

REVISIONS

ZONE	REV	DESCRIPTION	DATE	APPROVED

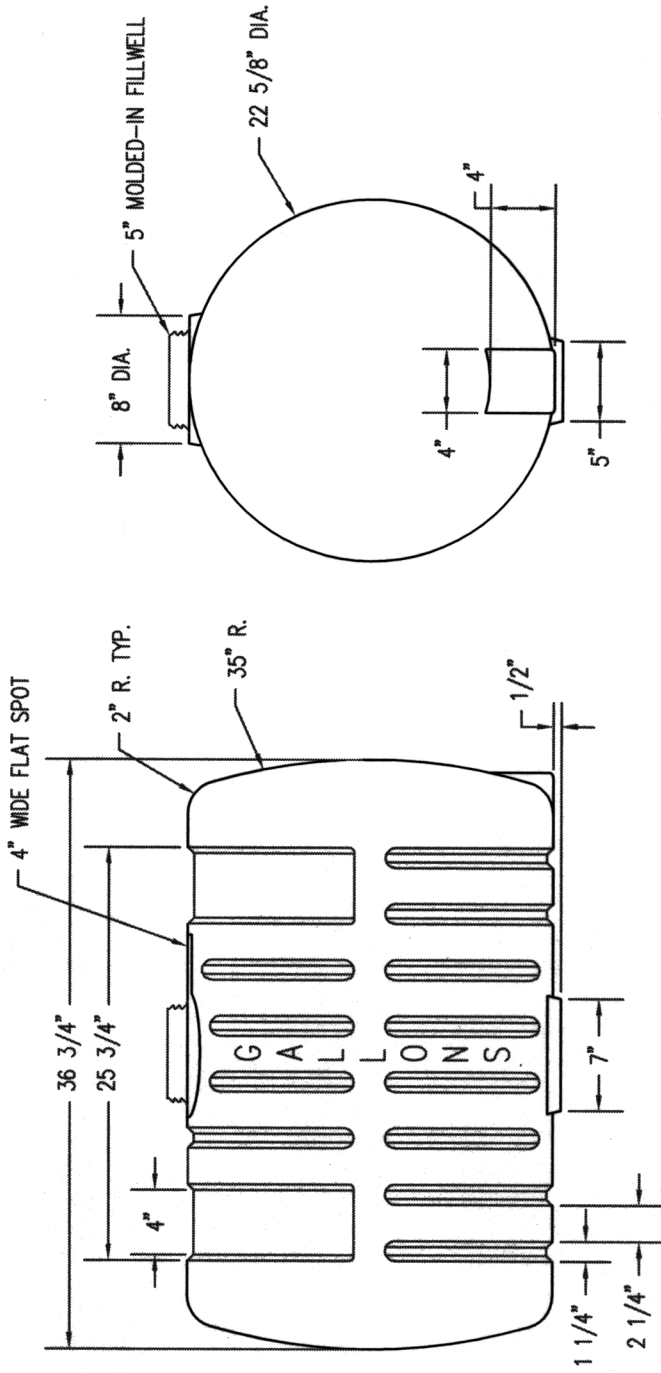

NORWESCO
ST. BONIFACIUS, MN

55 GALLON APPLICATOR
TANK

JTP	27JUN03	SIZE	FSCM NO.	DWG NO.	REV
		A		47233/47337	
SCALE 1/12				SHEET	